

F

E

D

C

B

A

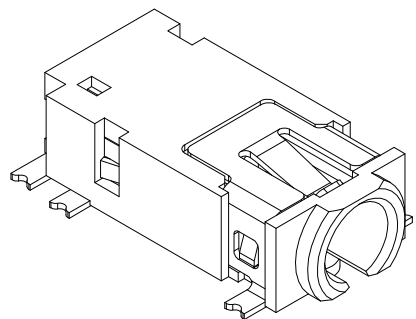

RoHS
Compliant

ZONE	SYMBOL	REVISION	APPROVAL	DATE
		ADDED INDICATION OF COPLANARITY	J.X.KUANG	25-12-2008

1

1

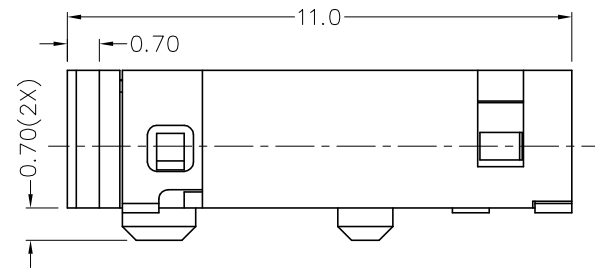
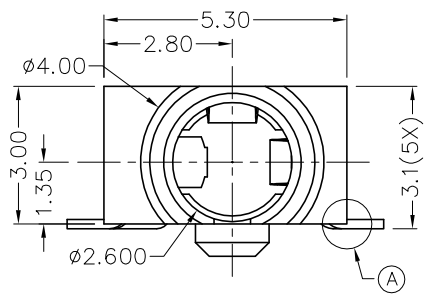
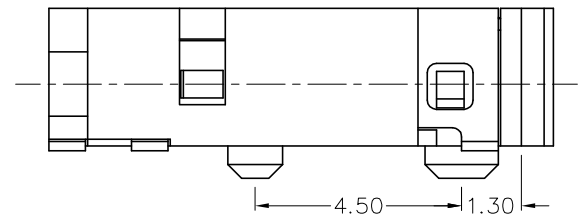

2

2

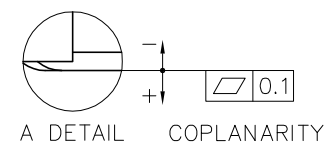
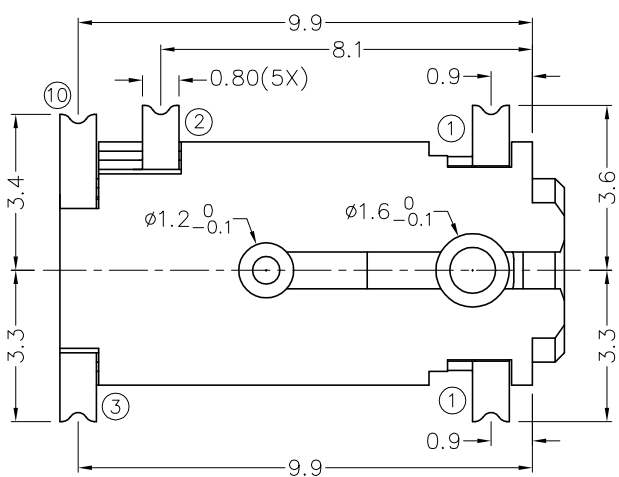

* MATERIAL
 TERMINAL 1 : COPPER ALLOY
 TERMINAL 2 : COPPER ALLOY
 TERMINAL 3 : COPPER ALLOY
 TERMINAL 10 : BRASS
 HOUSING : PA6T

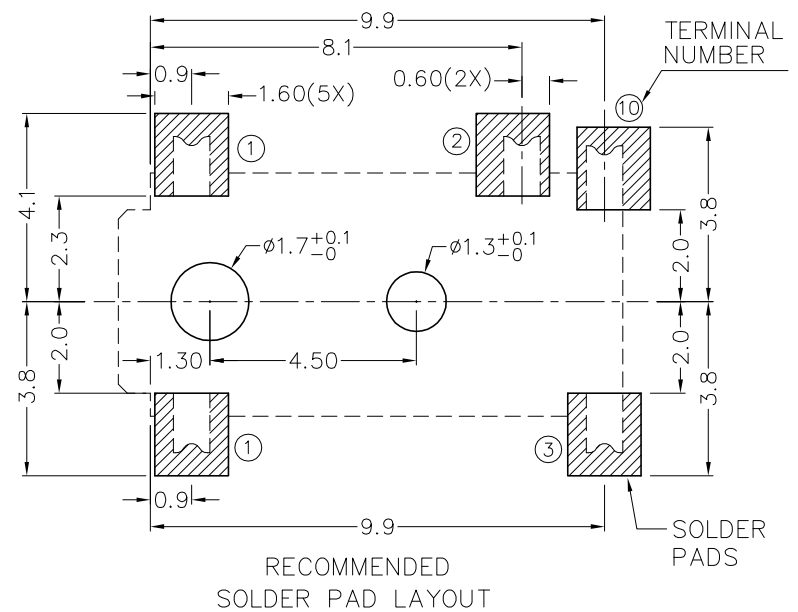

3

3

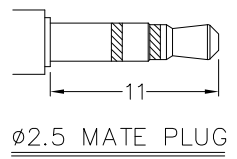

MODEL NO.	TG-2924D	TG-2923AD	TG-2923D
SCHEMATIC			

4

4

CHAMPWAY 冠泰电子有限公司
 CHAMPWAY ELECTRONICS CO., LTD.

DESIGN	T.Y.LI	DATE	10-8-2005	SCALE	6:1
DRAWING	T.Y.LI	DATE	25-12-2008	MATERIAL	*
CHECK		DATE		DWG. NO.	TZ\TG292D-PA6T/C
APPROVAL		DATE		SHEET	

PART NAME	2.5mm SMD STEREO JACK	TOLERANCE UNLESS	0.0±0.2	UNIT:	mm
PART NO.	TG-292D	OTHERWISE SPECIFIED:	0.00±0.1 0.000±0.05		

F

E

D

C

B

A