

F

E

D

C

B

A

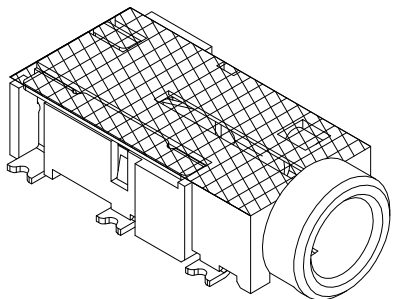

RoHS Compliant

ZONE	SYMBOL	REVISION	APPROVAL	DATE
		RENOVATED STRUCTURE	J.X.KUANG	17-9-2008

1

1

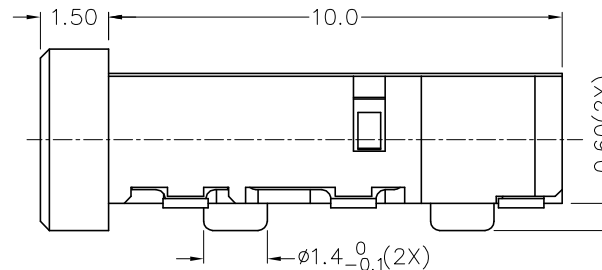
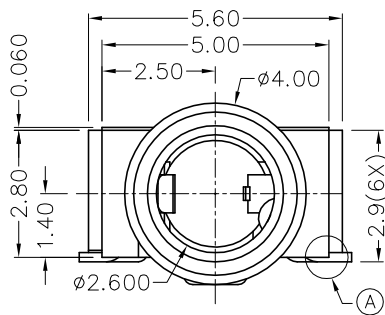
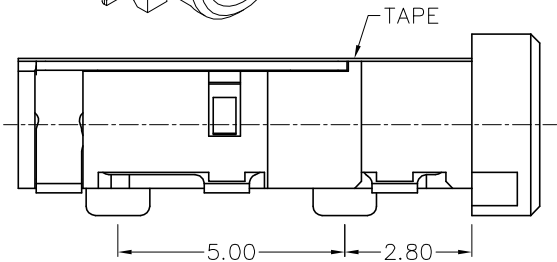

2

2

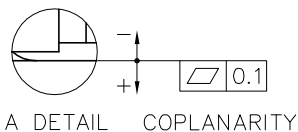
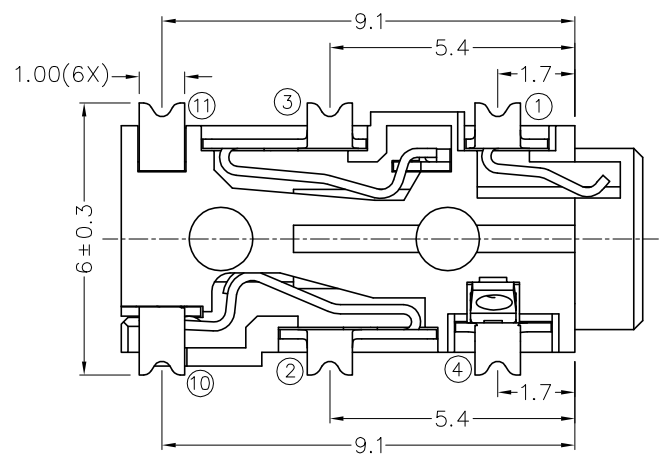

\* MATERIAL

- TERMINAL 1 : COPPER ALLOY
- TERMINAL 2 : COPPER ALLOY
- TERMINAL 3 : COPPER ALLOY
- TERMINAL 4 : COPPER ALLOY
- TERMINAL 10: COPPER ALLOY
- TERMINAL 11: COPPER ALLOY
- HOUSING : PA6T
- TAPE : POLYIMIDE

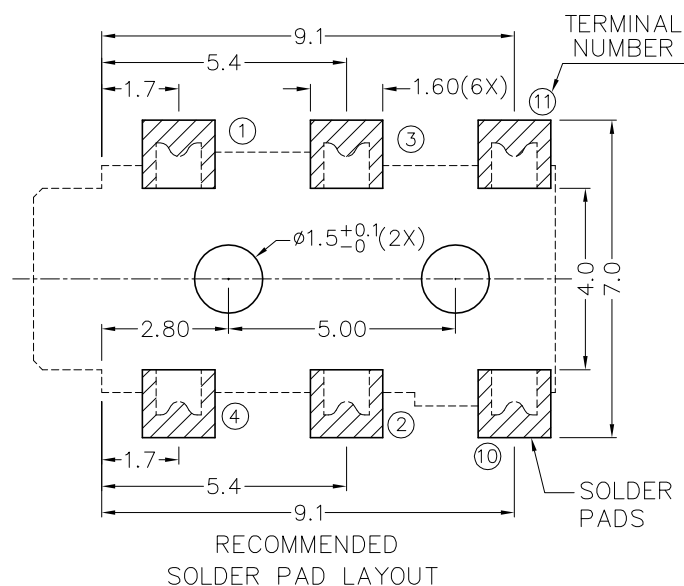

3

3

MODEL NO.	TG-2966DT1	TG-2965ADT1	TG-2965BDT1	TG-2964DT1
SCHMATIC				

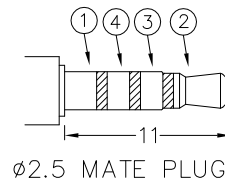

4

4

**CHAMPWAY** 冠泰電子有限公司  
CHAMPWAY ELECTRONICS CO., LTD.

DESIGN	T.Y.LI	DATE	9-6-2006	SCALE	6:1
DRAWING	T.Y.LI	DATE	17-9-2008	MATERIAL	*
CHECK		DATE		DWG. NO.	TZ\TG296DT1-PA6T/B
APPROVAL		DATE		SHEET	

PART NAME	2.5mm SMD STEREO JACK	TOLERANCE UNLESS	0.0±0.2	UNIT:	
PART NO.	TG-296DT1	OTHERWISE SPECIFIED:	0.00±0.1 0.000±0.05	mm	

F

E

D

C

B

A