

F

E

D

C

B

A

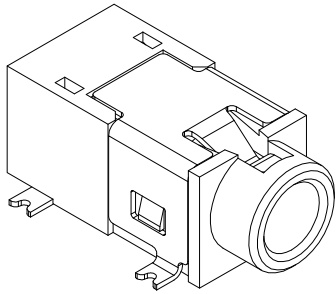

RoHS  
Compliant

ZONE	SYMBOL	REVISION	APPROVAL	DATE
		ADDED INDICATION OF COPLANARITY	J.X.KUANG	2-1-2009

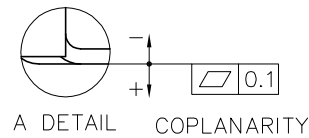
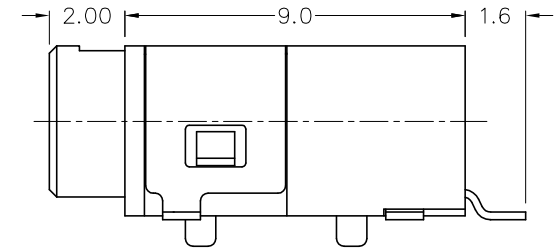
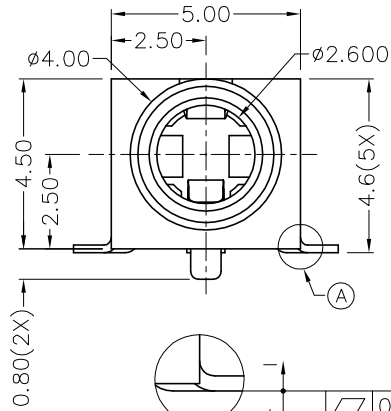
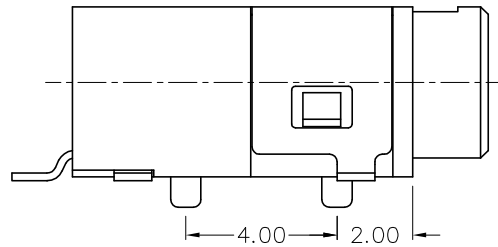

\* MATERIAL

TERMINAL 1 : COPPER ALLOY  
 TERMINAL 2 : COPPER ALLOY  
 TERMINAL 3 : COPPER ALLOY  
 TERMINAL 4 : COPPER ALLOY  
 HOUSING : PA6T

MODEL NO.	TG-4014D
SCHEMATIC	

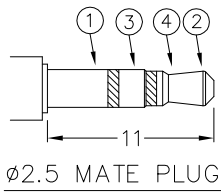
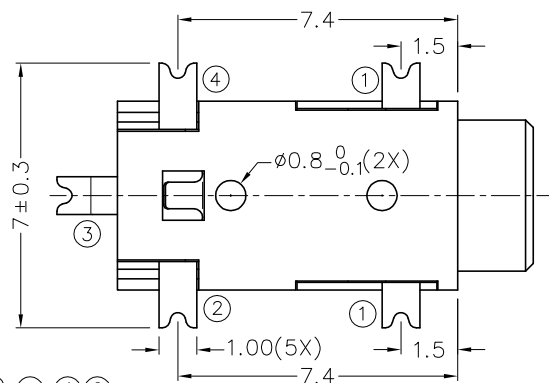
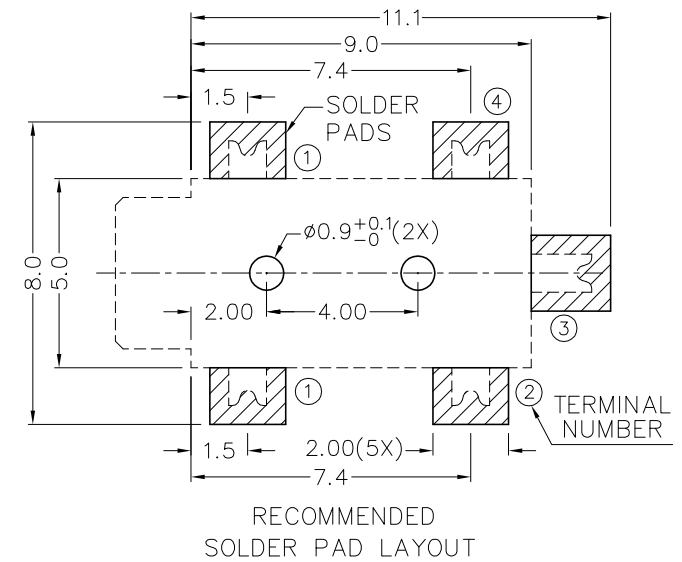

**CHAMPWAY** 冠泰電子有限公司  
 CHAMPWAY ELECTRONICS CO., LTD.

DESIGN	T.Y.LI	DATE	7-2-2007	SCALE	5:1
DRAWING	T.Y.LI	DATE	2-1-2009	MATERIAL	*
CHECK		DATE		DWG. NO.	TZ\TG401D-PA6T/B
APPROVAL		DATE		SHEET	

PART NAME	2.5mm SMD STEREO JACK	TOLERANCE UNLESS	0.0±0.2	UNIT:	mm
PART NO.	TG-401D	OTHERWISE SPECIFIED:	0.00±0.1 0.000±0.05		

F

E

D

C

B

A