

F

E

D

C

B

A

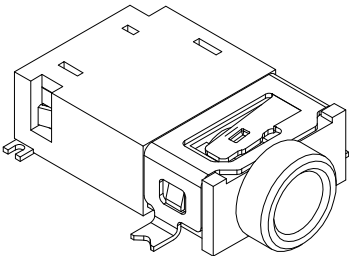

RoHS
Compliant

ZONE	SYMBOL	REVISION	APPROVAL	DATE
		ADDED INDICATION OF COPLANARITY	J.X.KUANG	23-12-2008

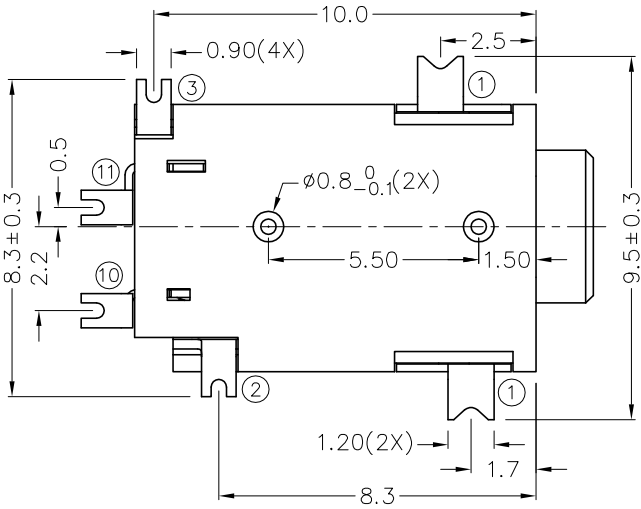
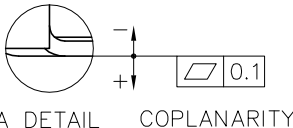
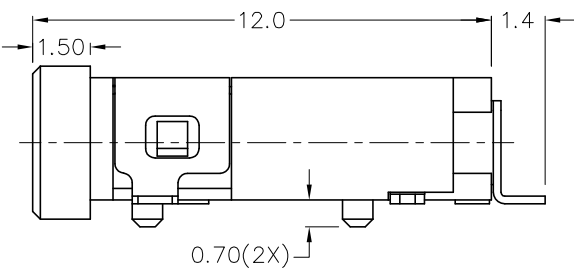
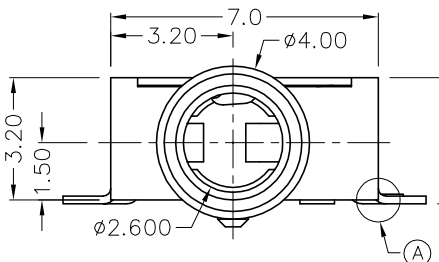
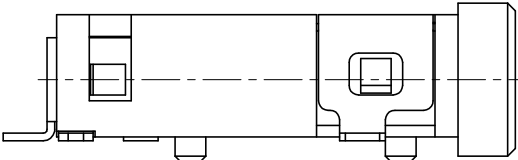

- * MATERIAL
- TERMINAL 1 : COPPER ALLOY
 - TERMINAL 2 : COPPER ALLOY
 - TERMINAL 3 : COPPER ALLOY
 - TERMINAL 10 : BRASS
 - TERMINAL 11 : BRASS
 - HOUSING : PA6T

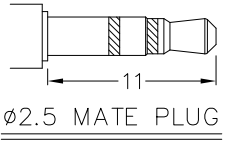
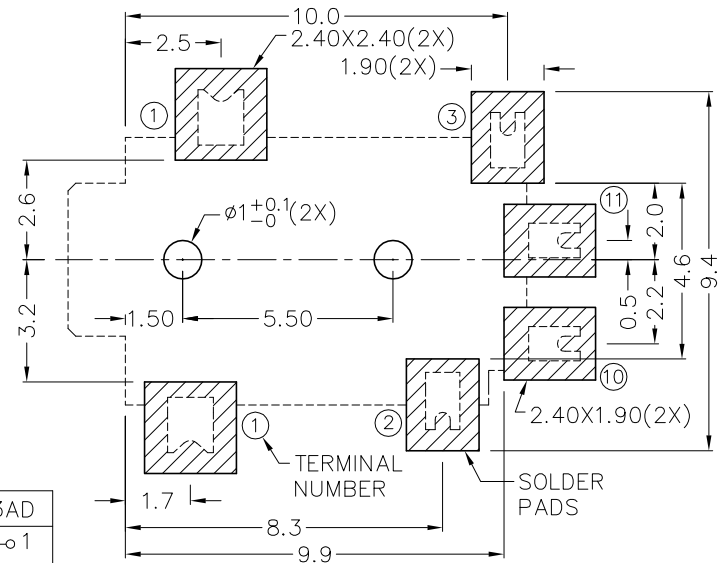

MODEL NO.	TG-2835D	TG-2834AD	TG-2834BD	TG-2833D	TG-2833AD
SCHEMATIC					

CHAMPWAY 冠泰電子有限公司
CHAMPWAY ELECTRONICS CO., LTD.

DESIGN	T.Y.LI	DATE	21-8-2003	SCALE	5:1
DRAWING	T.Y.LI	DATE	23-12-2008	MATERIAL	*
CHECK		DATE		DWG. NO.	TZ\TG283D-PA6T/C
APPROVAL		DATE		SHEET	

PART NAME	2.5mm SMD STEREO JACK	TOLERANCE UNLESS	0.0±0.2	UNIT:	
PART NO.	TG-283D	OTHERWISE SPECIFIED:	0.00±0.1 0.000±0.05	mm	

F

E

D

C

B

A