

F

E

D

C

B

A

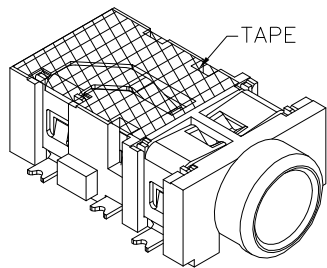

TAPE

RoHS
Compliant

ZONE	SYMBOL	REVISION	APPROVAL	DATE

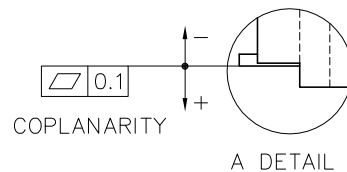
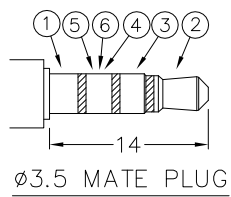
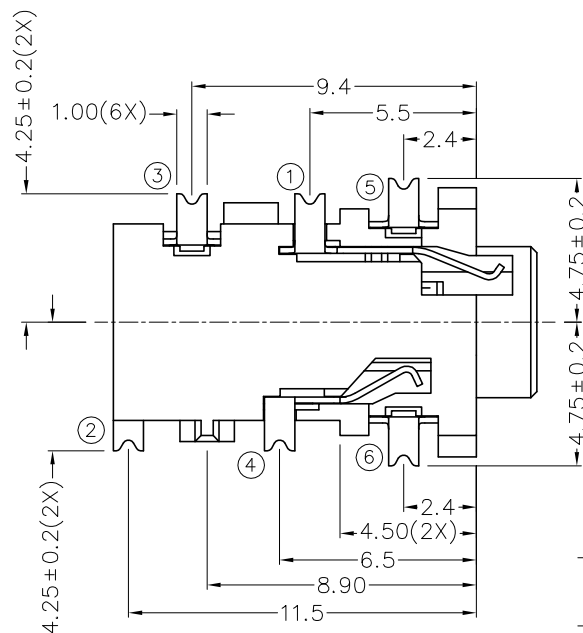
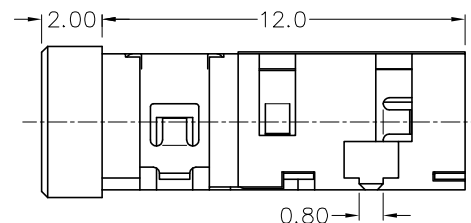
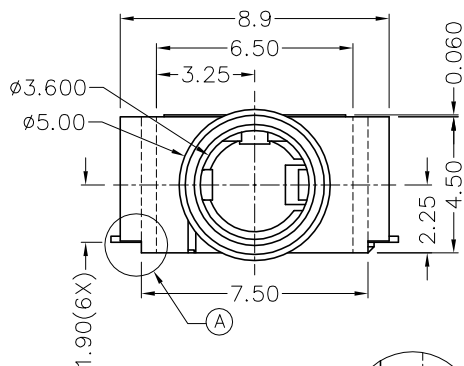
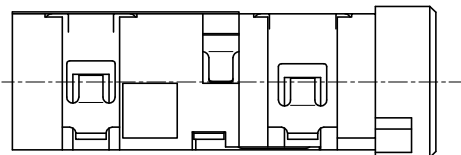

* MATERIAL

TERMINAL 1 : COPPER ALLOY
 TERMINAL 2 : COPPER ALLOY
 TERMINAL 3 : COPPER ALLOY
 TERMINAL 4 : COPPER ALLOY
 TERMINAL 5 : COPPER ALLOY
 TERMINAL 6 : COPPER ALLOY
 HOUSING : PA6T
 TAPE : POLYIMIDE

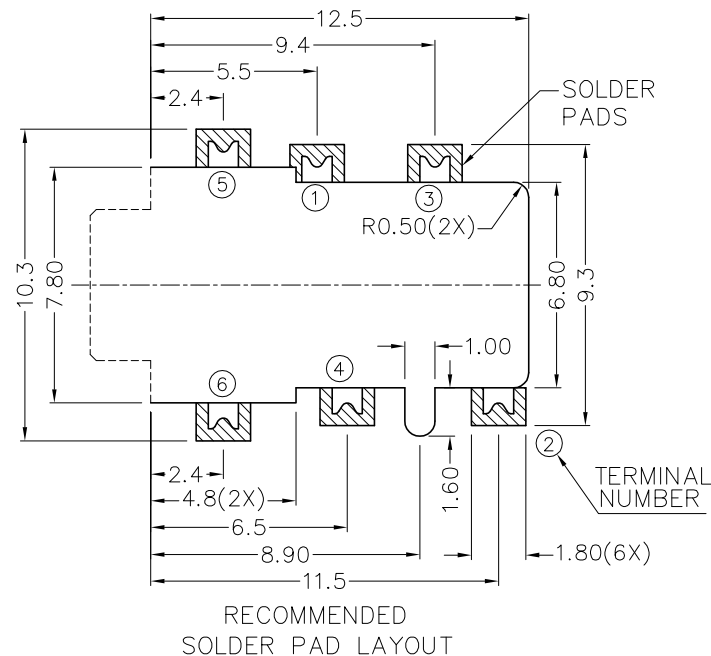
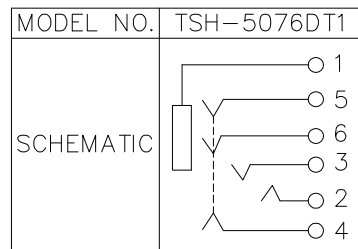

CHAMPWAY 冠泰電子有限公司
 CHAMPWAY ELECTRONICS CO., LTD.

DESIGN	X.N.ZHENG	DATE	31-10-2008	SCALE	4:1
DRAWING	T.Y.LI	DATE	2-3-2009	MATERIAL	*
CHECK		DATE		DWG. NO.	TZ\SH507DT1-PA6T/A
APPROVAL		DATE		SHEET	

PART NAME	3.5mm SMD STEREO JACK	TOLERANCE UNLESS	0.0±0.2	UNIT:	mm
PART NO.	TSH-507DT1	OTHERWISE SPECIFIED:	0.00±0.1 0.000±0.05		

F

E

D

C

B

A