

F

E

D

C

B

A

ZONE	SYMBOL	REVISION	APPROVAL	DATE

RoHS
Compliant

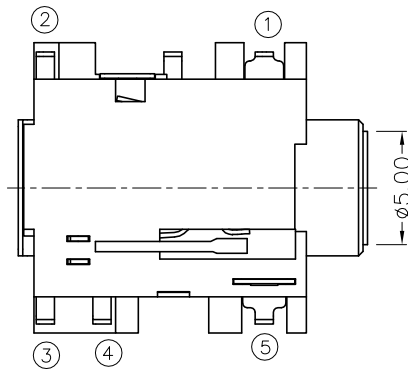
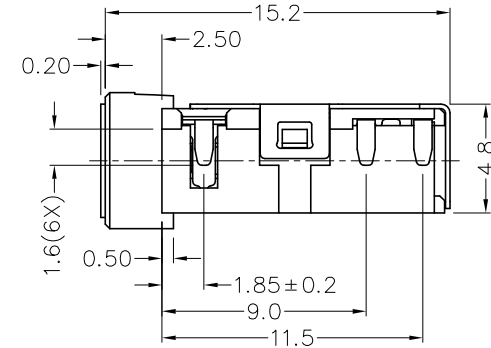
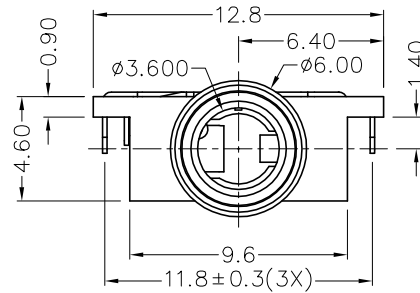
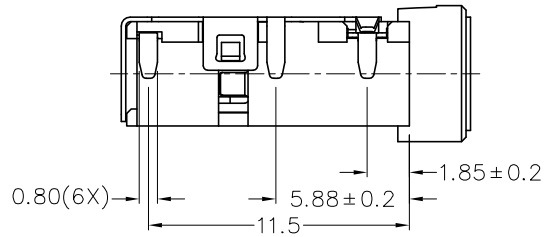
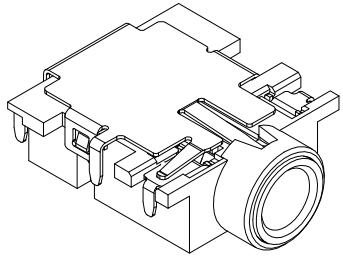

* MATERIAL

TERMINAL 1 : COPPER ALLOY
 TERMINAL 2 : COPPER ALLOY
 TERMINAL 3 : COPPER ALLOY
 TERMINAL 4 : COPPER ALLOY
 TERMINAL 5 : COPPER ALLOY
 SHIELD : COPPER ALLOY
 BUSHING : BRASS
 HOUSING : PA9T

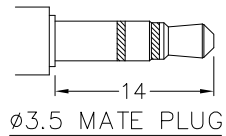
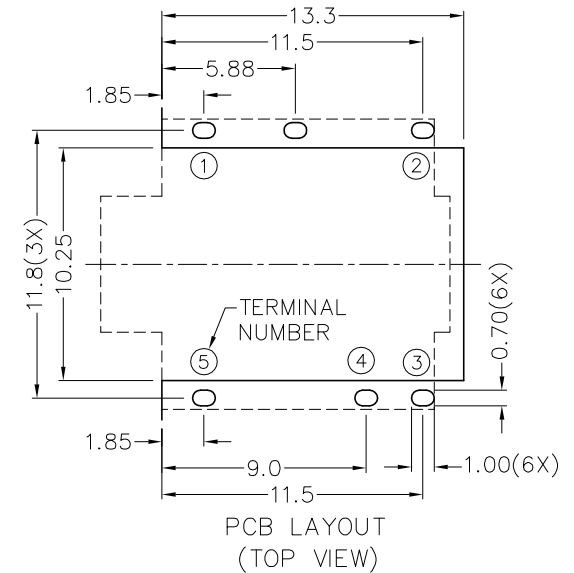

MODEL NO.	TSH-5085DS
SCHEMATIC	○ SHIELDING
	○ 1
	○ 2
	○ 3
	○ 4
○ 5	



CHAMPWAY 冠泰電子有限公司
 CHAMPWAY ELECTRONICS CO., LTD.

DESIGN	T.Y.LI	DATE	9-1-2009	SCALE	3:1
DRAWING	T.Y.LI	DATE	24-2-2009	MATERIAL	*
CHECK		DATE		DWG. NO.	TZ\SH508DS-PA9T/A
APPROVAL		DATE		SHEET	

PART NAME	3.5mm SMD STEREO JACK	TOLERANCE UNLESS	0.0±0.2	UNIT:
PART NO.	TSH-508DS	OTHERWISE SPECIFIED:	0.00±0.1 0.000±0.05	

F

E

D

C

B

A