

F

E

D

C

B

A

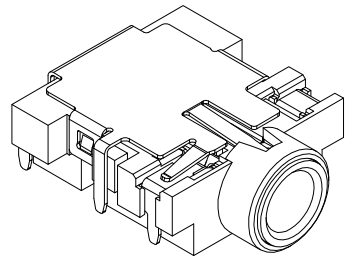

RoHS
Compliant

ZONE	SYMBOL	REVISION	APPROVAL	DATE

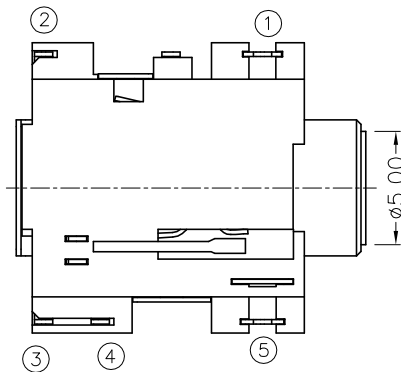
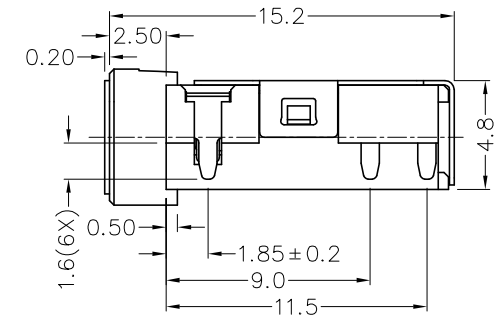
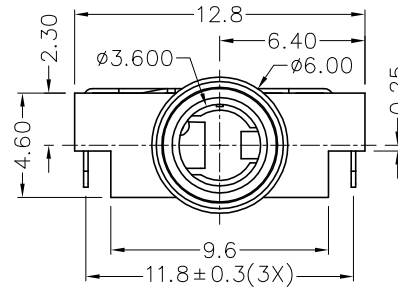
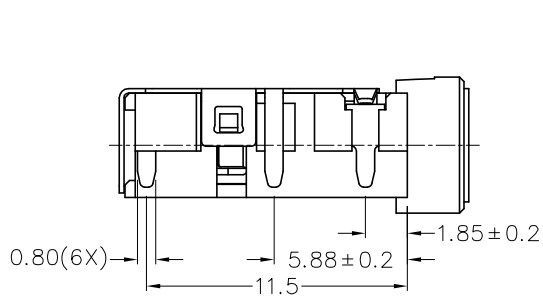

* MATERIAL

TERMINAL 1 : COPPER ALLOY
 TERMINAL 2 : COPPER ALLOY
 TERMINAL 3 : COPPER ALLOY
 TERMINAL 4 : COPPER ALLOY
 TERMINAL 5 : COPPER ALLOY
 SHIELD : COPPER ALLOY
 BUSHING : BRASS
 HOUSING : PA9T

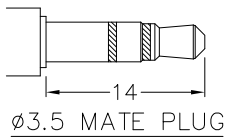
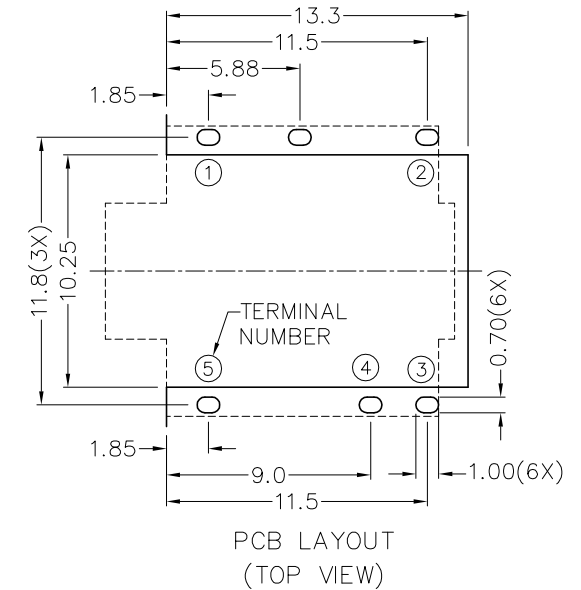
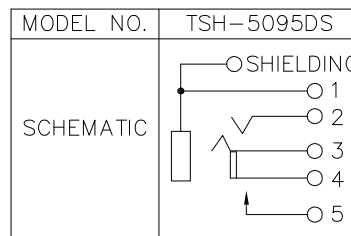

CHAMPWAY 冠泰電子有限公司
 CHAMPWAY ELECTRONICS CO., LTD.

PART NAME	3.5mm SMD STEREO JACK	TOLERANCE UNLESS 0.0±0.2 0.00±0.1 OTHERWISE SPECIFIED: 0.000±0.05	UNIT: mm	DESIGN	T.Y.LI	DATE	10-1-2009	SCALE	3:1
				DRAWING	T.Y.LI	DATE	17-2-2009	MATERIAL	*
PART NO.	TSH-509DS			CHECK		DATE		DWG. NO.	TZ\SH509DS-PA9T/A
				APPROVAL		DATE		SHEET	

F

E

D

C

B

A