

F

E

D

C

B

A

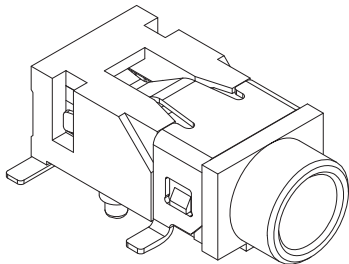

RoHS  
Compliant

ZONE	SYMBOL	REVISION	APPROVAL	DATE
		DESIGN CHANGED	J.X.KUANG	6-1-2012

1

1

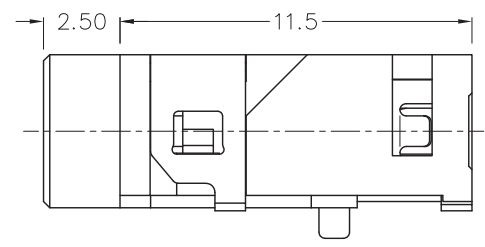
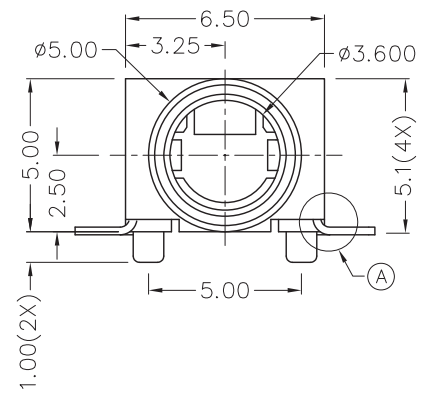
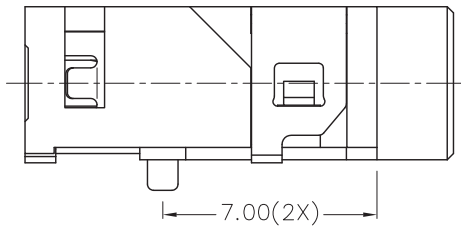

2

2

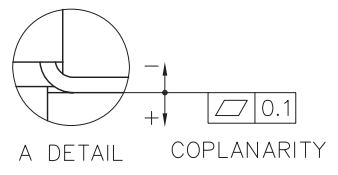
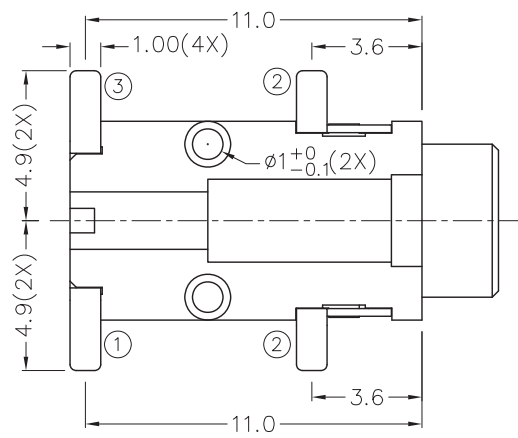

\* MATERIAL  
 TERMINAL 1 : COPPER ALLOY  
 TERMINAL 2 : COPPER ALLOY  
 TERMINAL 3 : COPPER ALLOY  
 HOUSING : PA6T

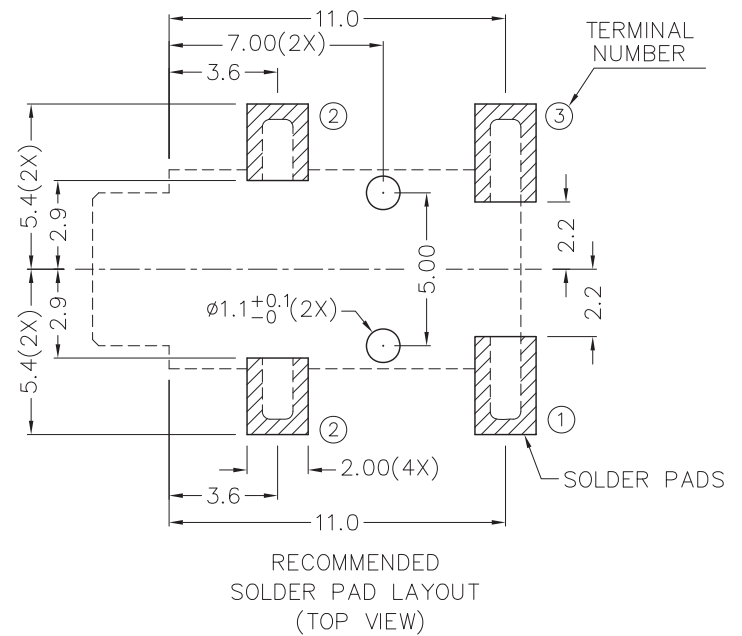

3

3

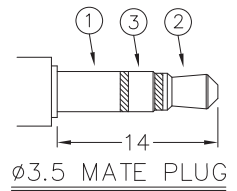

MODEL NO.	TSH-3733D
SCHEMATIC	

4

4

**CHAMPWAY** 冠泰電子有限公司  
CHAMPWAY ELECTRONICS CO., LTD.

PART NAME	3.5mm SMD STEREO JACK	TOLERANCE UNLESS	0.0±0.2	UNIT:	
PART NO.	TSH-373D	OTHERWISE SPECIFIED:	0.00±0.1 0.000±0.05		

DESIGN	J.JIANG	DATE	3-5-2004	SCALE	4:1
DRAWING	CH.XIONG	DATE	6-1-2012	MATERIAL	*
CHECK		DATE		DWG. NO.	TZ\SH373D-PA6T/E
APPROVAL		DATE		SHEET	

F

E

D

C

B

A