

F E D C B A

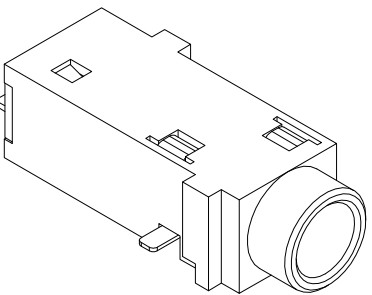

RoHS
Compliant

ZONE	SYMBOL	REVISION	APPROVAL	DATE
		ADDED INDICATION OF COPLANARITY	J.X.KUANG	20-11-2008

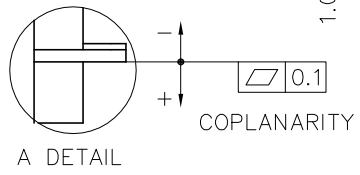
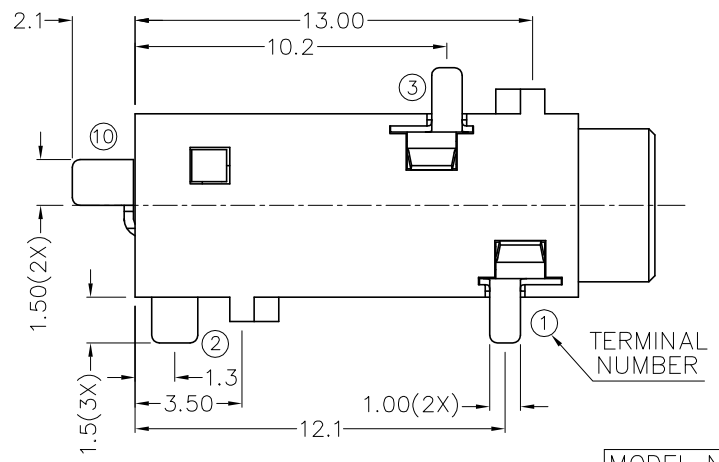
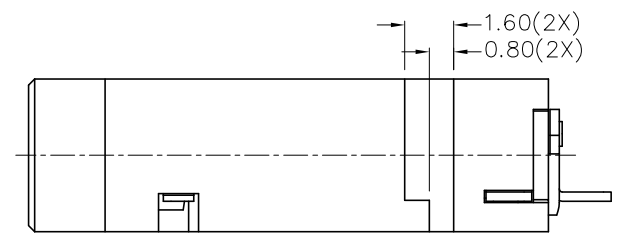
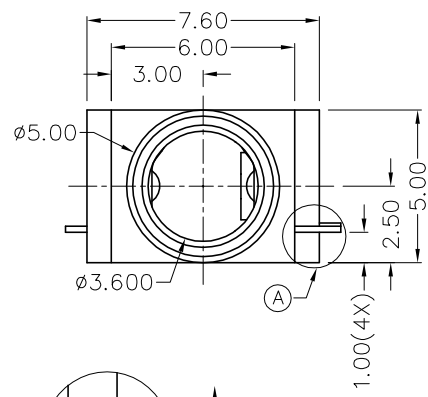
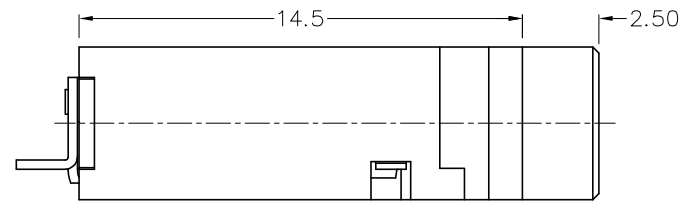

* MATERIAL
 TERMINAL 1 : COPPER ALLOY
 TERMINAL 2 : COPPER ALLOY
 TERMINAL 3 : COPPER ALLOY
 TERMINAL 10 : BRASS
 HOUSING : PA6T
 COVER : PA6T

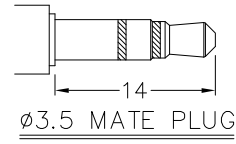
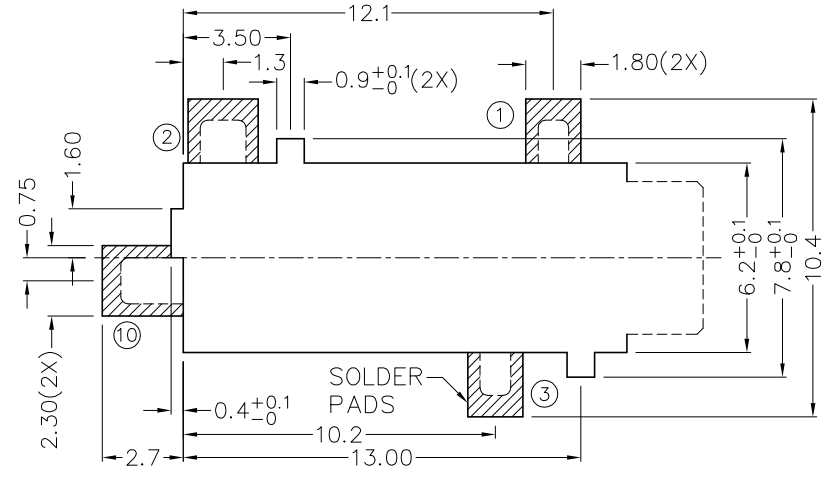

MODEL NO.	TSH-3804D	TSH-3803D	TSH-3803AD
SCHEMATIC			

CHAMPWAY 冠泰電子有限公司
 CHAMPWAY ELECTRONICS CO., LTD.

DESIGN	J.X.KUANG	DATE	7-10-2003	SCALE	4:1
DRAWING	T.Y.LI	DATE	20-11-2008	MATERIAL	*
CHECK		DATE		DWG. NO.	TZ\SH380D-PA6T/C
APPROVAL		DATE		SHEET	

PART NAME	3.5mm SMD STEREO JACK	TOLERANCE UNLESS	0.0±0.2	UNIT:	
PART NO.	TSH-380D	OTHERWISE SPECIFIED:	0.00±0.1 0.000±0.05	mm	

F E D C B A