

F

E

D

C

B

A

RoHS  
Compliant

ZONE	SYMBOL	REVISION	APPROVAL	DATE
		ADDED INDICATION OF COPLANARITY	J.X.KUANG	28-11-2008

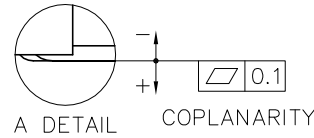
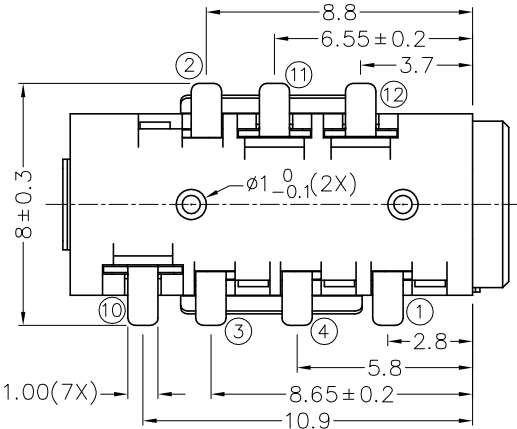
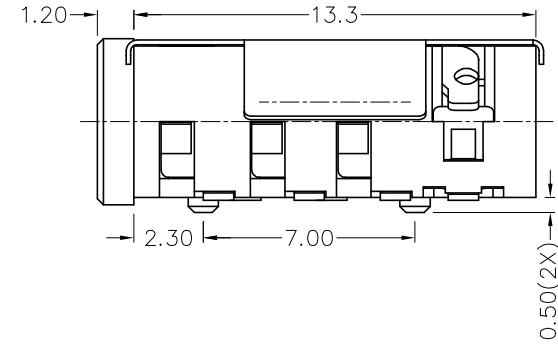
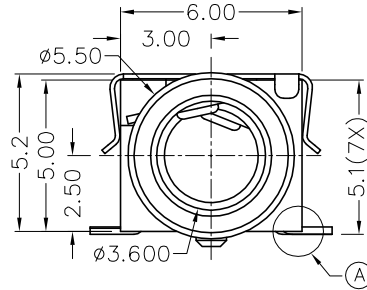
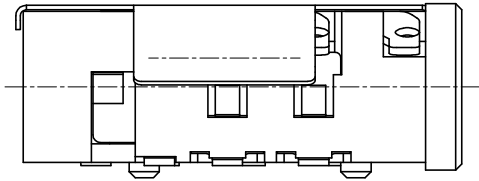
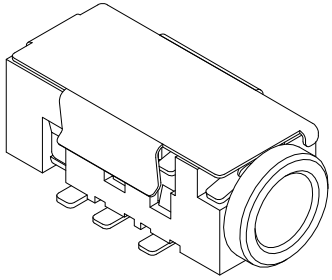

\* MATERIAL

- TERMINAL 1 : COPPER ALLOY
- TERMINAL 2 : COPPER ALLOY
- TERMINAL 3 : COPPER ALLOY
- TERMINAL 4 : COPPER ALLOY
- TERMINAL 10 : BRASS
- TERMINAL 11 : BRASS
- TERMINAL 12 : BRASS
- SHIELD : STAINLESS STEEL
- HOUSING : PA6T

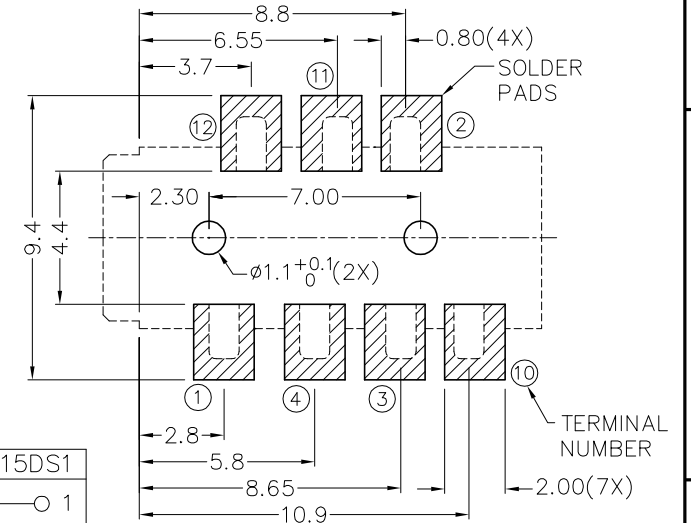
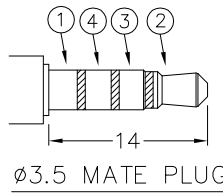

MODEL NO.	TSH-3917DS1	TSH-3916ADS1	TSH-3915ADS1	TSH-3915CDS1	TSH-3914DS1	TSH-3915DS1
SCHEMATIC						

**CHAMPWAY** 冠泰電子有限公司  
CHAMPWAY ELECTRONICS CO., LTD.

DESIGN	T.Y.LI	DATE	23-3-2006	SCALE	4:1
DRAWING	T.Y.LI	DATE	28-11-2008	MATERIAL	*
CHECK		DATE		DWG. NO.	TZ\SH391DS1-PA6T/D
APPROVAL		DATE		SHEET	

PART NAME	3.5mm SMD STEREO JACK W/HANDING SHIELD	TOLERANCE UNLESS	0.0±0.2	UNIT:	
PART NO.	TSH-391DS1	OTHERWISE SPECIFIED:	0.00±0.1 0.000±0.05	mm	

F

E

D

C

B

A