

F

E

D

C

B

A

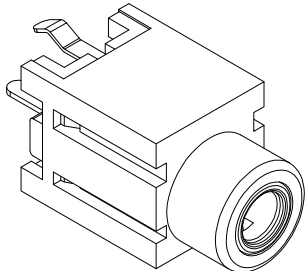

RoHS
Compliant

| ZONE | SYMBOL | REVISION | APPROVAL | DATE |
|------|--------|----------|----------|------|
| | | | | |
| | | | | |
| | | | | |

1

1

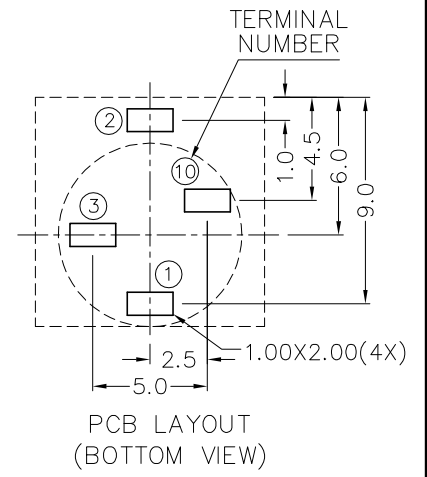
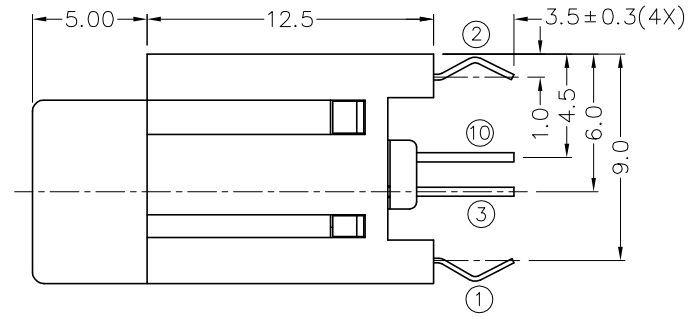
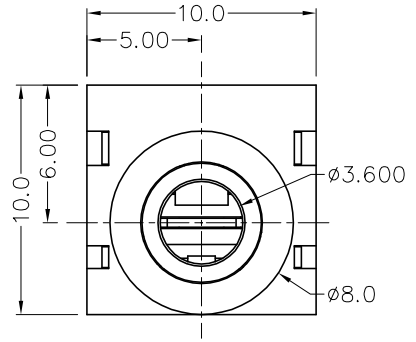
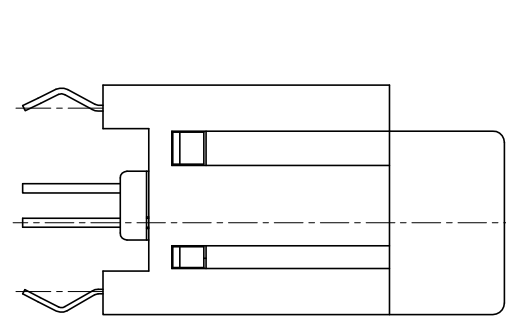

2

2

3

3

* MATERIAL
 TERMINAL 1 : COPPER ALLOY
 TERMINAL 2 : COPPER ALLOY
 TERMINAL 3 : BRASS
 TERMINAL 10 : BRASS
 BUSHING : BRASS
 HOUSING : PBT
 COVER : PBT

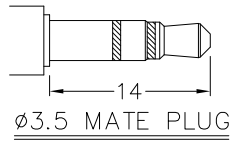
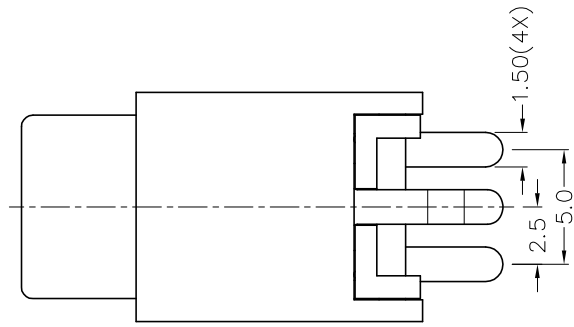

| MODEL NO. | TSH-3834M | TSH-3833M | TSH-3833AM |
|-----------|-----------|-----------|------------|
| SCHEMATIC | | | |

4

4

CHAMPWAY 冠泰電子有限公司
 CHAMPWAY ELECTRONICS CO., LTD.

| | | | | | |
|----------|--------|------|-----------|----------|-----------------|
| DESIGN | T.Y.LI | DATE | 27-2-2008 | SCALE | 3:1 |
| DRAWING | T.Y.LI | DATE | 27-2-2008 | MATERIAL | * |
| CHECK | | DATE | | DWG. NO. | TZ\SH383M-PBT/A |
| APPROVAL | | DATE | | SHEET | |

| | | | | |
|-----------|-------------------|----------------------|------------------------|-------|
| PART NAME | 3.5mm STEREO JACK | TOLERANCE UNLESS | 0.0±0.2 | UNIT: |
| PART NO. | TSH-383M | OTHERWISE SPECIFIED: | 0.00±0.1 0.000±0.05 | |

F

E

D

C

B

A