

F

E

D

C

B

A

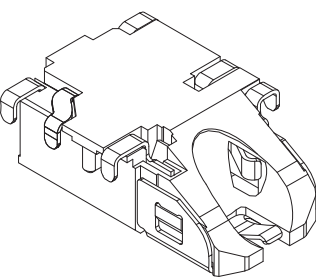

RoHS
Compliant

ZONE	SYMBOL	REVISION	APPROVAL	DATE

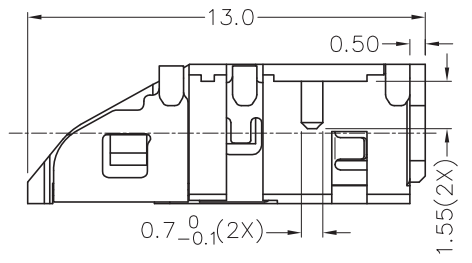
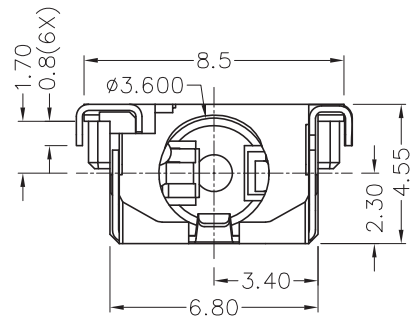
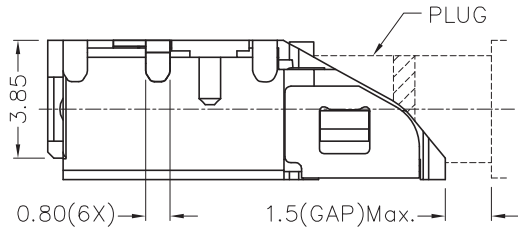

1

1

2

2

3

3

4

4

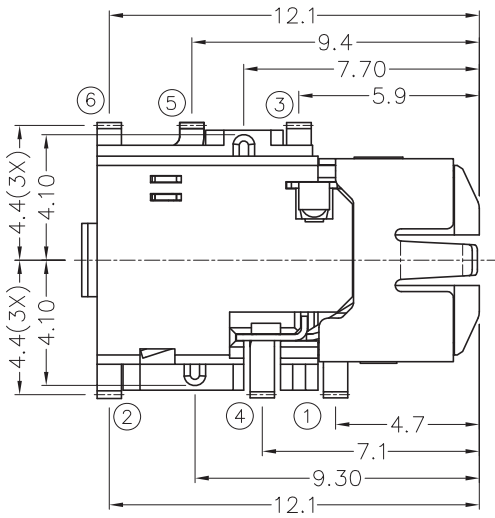

* MATERIAL
 TERMINAL 1 : COPPER ALLOY
 TERMINAL 2 : COPPER ALLOY
 TERMINAL 3 : COPPER ALLOY
 TERMINAL 4 : COPPER ALLOY
 TERMINAL 5 : COPPER ALLOY
 TERMINAL 6 : COPPER ALLOY
 HOUSING : PA10T
 INSULATOR : PA10T

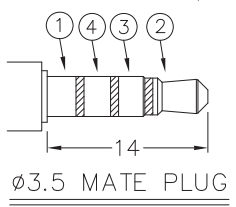
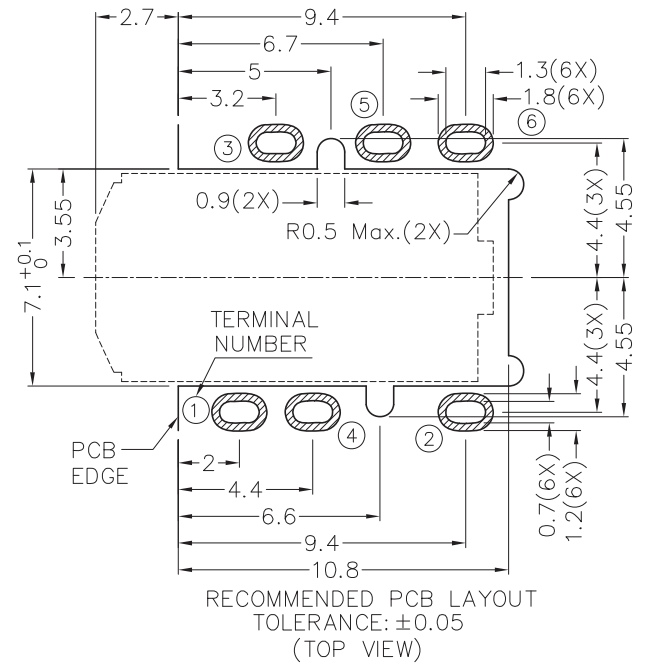
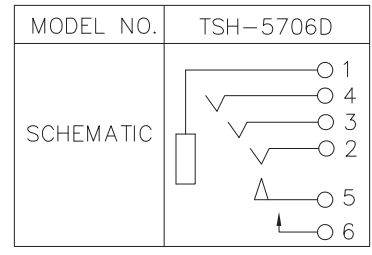

CHAMPWAY 冠泰电子有限公司
CHAMPWAY ELECTRONICS CO., LTD.

DESIGN	D.LIU	DATE	25-1-2013	SCALE	4:1
DRAWING	G.P.YI	DATE	3-5-2013	MATERIAL	*
CHECK		DATE		DWG. NO.	TZ\SH570D-PA10T/A
APPROVAL		DATE		SHEET	

PART NAME	3.5mm SMD STEREO JACK	TOLERANCE UNLESS	0.0±0.2	UNIT: mm	
PART NO.	TSH-570D	OTHERWISE SPECIFIED:	0.00±0.1 0.000±0.05		

F

E

D

C

B

A