

F

E

D

C

B

A

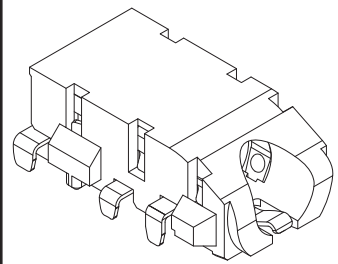

RoHS
Compliant

ZONE	SYMBOL	REVISION	APPROVAL	DATE

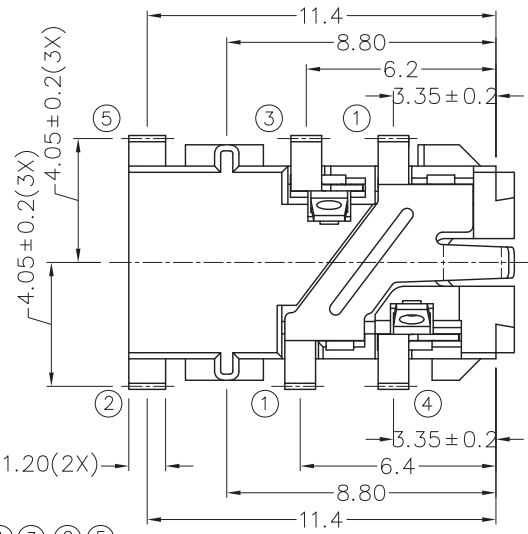
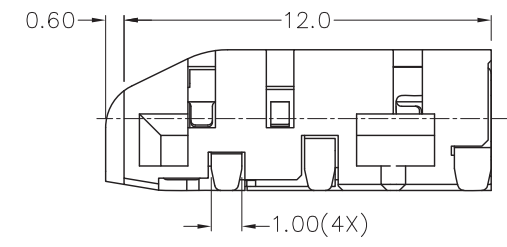
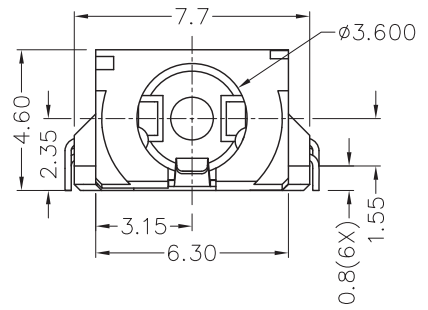
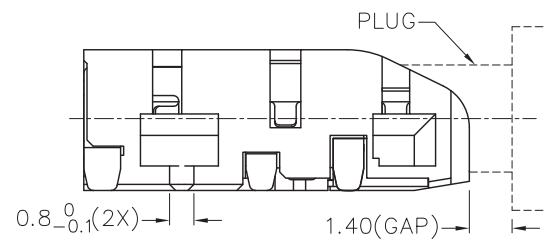

*** MATERIAL**
 TERMINAL 1 : COPPER ALLOY
 TERMINAL 2 : COPPER ALLOY
 TERMINAL 3 : COPPER ALLOY
 TERMINAL 4 : COPPER ALLOY
 TERMINAL 5 : COPPER ALLOY
 HOUSING : PA6T

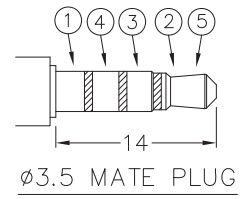
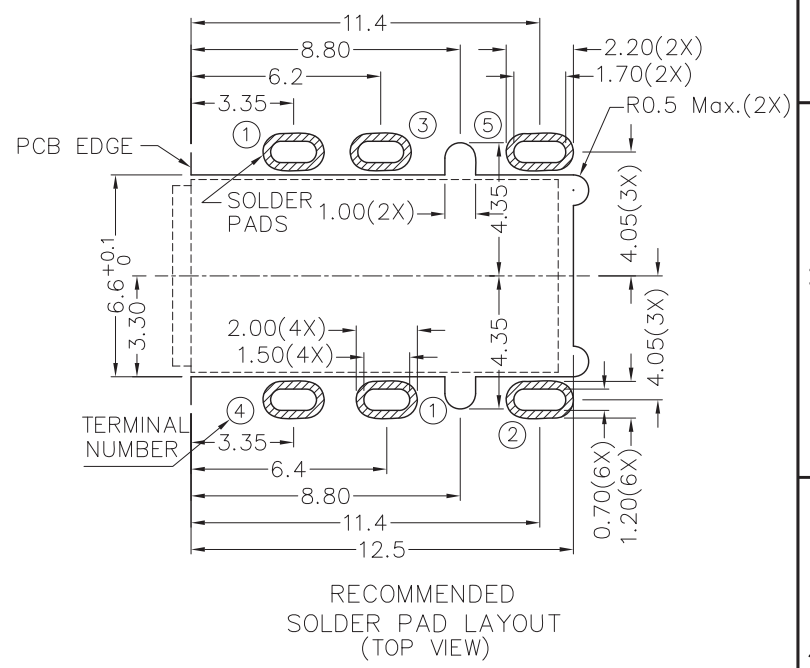
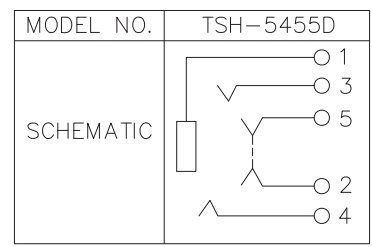

CHAMPWAY 冠泰電子有限公司
 CHAMPWAY ELECTRONICS CO., LTD.

PART NAME	3.5mm SMD STEREO JACK	TOLERANCE UNLESS	0.0±0.2	UNIT:
PART NO.	TSH-545D	OTHERWISE SPECIFIED:	0.00±0.1 0.000±0.05	

DESIGN	H.L.TAN	DATE	7-4-2012	SCALE	4:1
DRAWING	H.L.TAN	DATE	13-4-2012	MATERIAL	*
CHECK		DATE		DWG. NO.	TZ\SH545D-PA6T/A
APPROVAL		DATE		SHEET	

F

E

D

C

B

A