

F

E

D

C

B

A

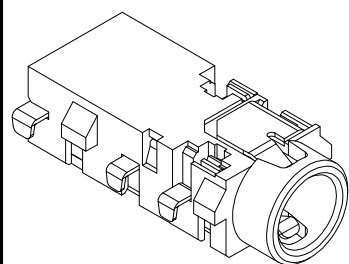

RoHS
Compliant

ZONE	SYMBOL	REVISION	APPROVAL	DATE

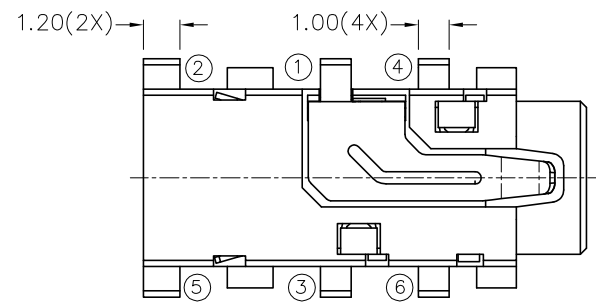
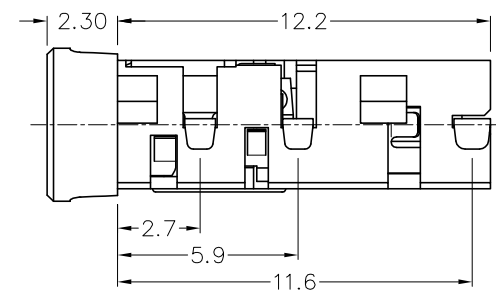
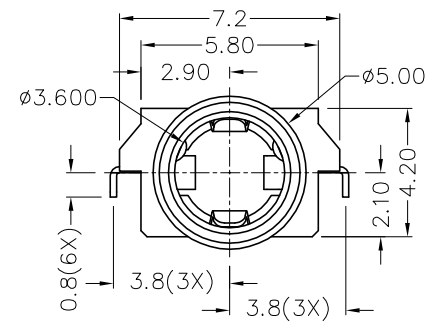
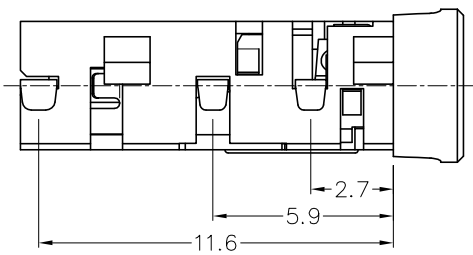

* MATERIAL

- TERMINAL 1 : COPPER ALLOY
- TERMINAL 2 : COPPER ALLOY
- TERMINAL 3 : COPPER ALLOY
- TERMINAL 4 : COPPER ALLOY
- TERMINAL 5 : COPPER ALLOY
- TERMINAL 6 : COPPER ALLOY
- HOUSING : PA6T

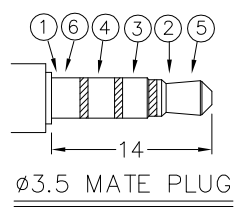
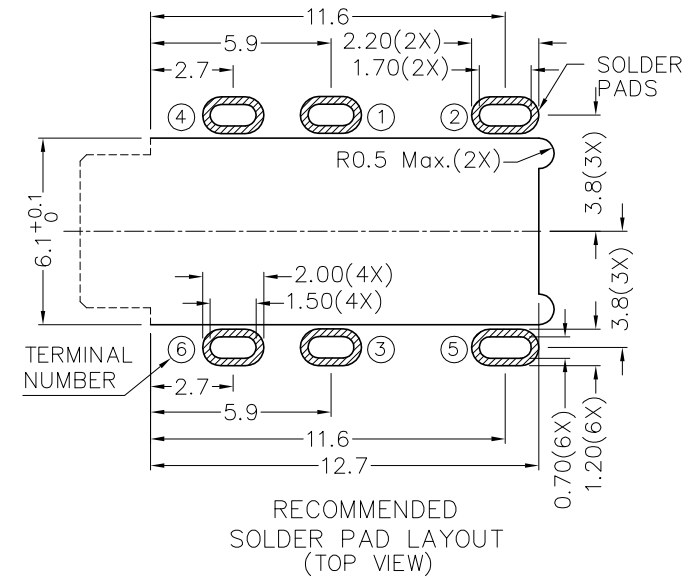
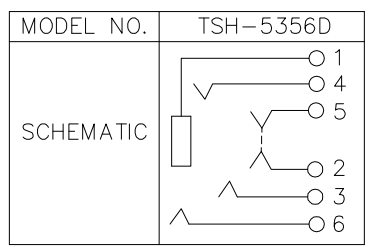

CHAMPWAY 冠泰電子有限公司
CHAMPWAY ELECTRONICS CO., LTD.

DESIGN	CH.XIONG	DATE	4-5-2011	SCALE	4:1
DRAWING	CH.XIONG	DATE	4-5-2011	MATERIAL	*
CHECK		DATE		DWG. NO.	TZ\SH535D-PA6T/A
APPROVAL		DATE		SHEET	

PART NAME	3.5mm SMD STEREO JACK	TOLERANCE UNLESS	0.0±0.2	UNIT:	mm
PART NO.	TSH-535D	OTHERWISE SPECIFIED:	0.00±0.1 0.00±0.05		

F

E

D

C

B

A