

F

E

D

C

B

A

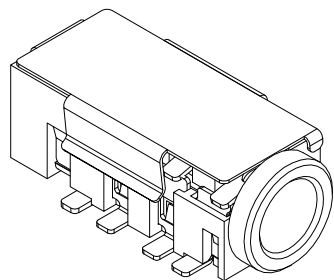

RoHS
Compliant

ZONE	SYMBOL	REVISION	APPROVAL	DATE

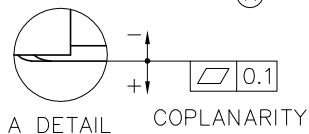
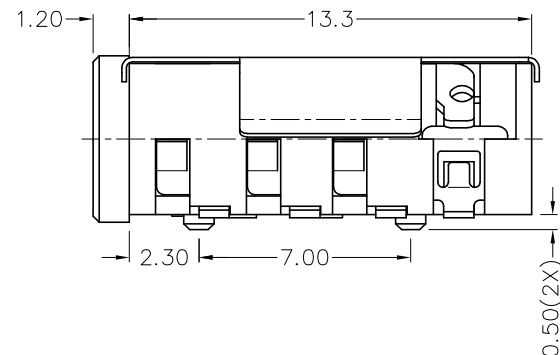
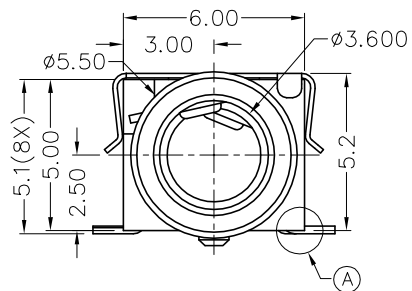
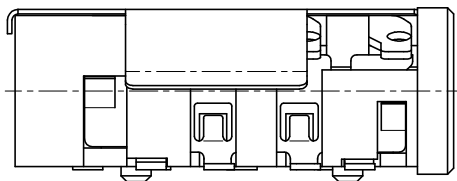

* MATERIAL

TERMINAL 1 : COPPER ALLOY
 TERMINAL 2 : COPPER ALLOY
 TERMINAL 3 : COPPER ALLOY
 TERMINAL 4 : COPPER ALLOY
 TERMINAL 10 : COPPER ALLOY
 TERMINAL 11 : COPPER ALLOY
 TERMINAL 12 : COPPER ALLOY
 TERMINAL 13 : COPPER ALLOY
 SHIELD : STAINLESS STEEL
 HOUSING : PA6T

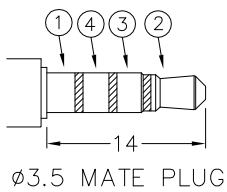
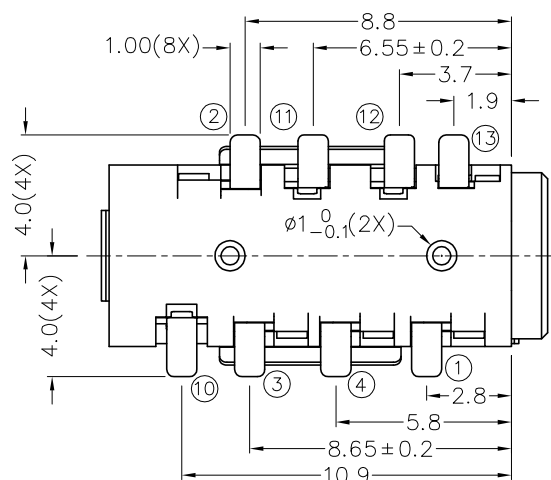
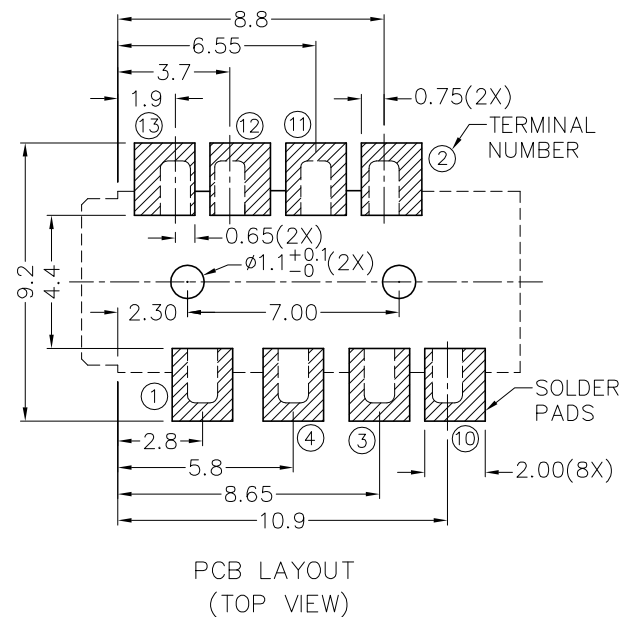
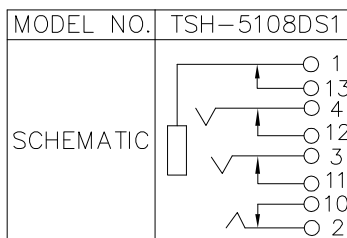

CHAMPWAY 冠泰電子有限公司
 CHAMPWAY ELECTRONICS CO., LTD.

DESIGN	T.Y.LI	DATE	4-3-2009	SCALE	4:1
DRAWING	T.Y.LI	DATE	4-3-2009	MATERIAL	*
CHECK		DATE		DWG. NO.	TZ\SH510DS1-PA6T/A
APPROVAL		DATE		SHEET	

PART NAME 3.5mm SMD STEREO JACK W/HANDING SHIELD
 PART NO. TSH-510DS1

TOLERANCE UNLESS 0.0±0.2
 OTHERWISE SPECIFIED: 0.00±0.1
 0.000±0.05

UNIT: mm



F

E

D

C

B

A