

F

E

D

C

B

A

ZONE	SYMBOL	REVISION	APPROVAL	DATE

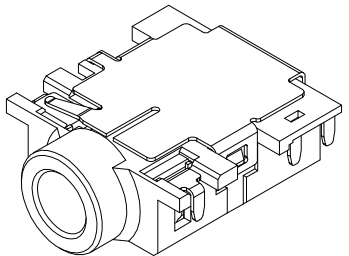

RoHS
Compliant

1

1

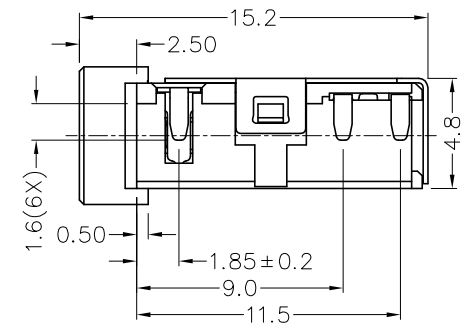
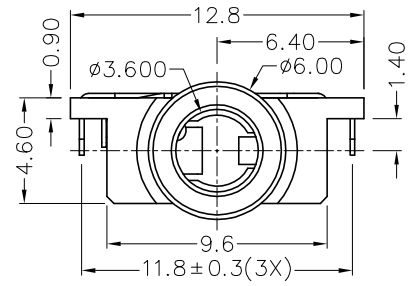
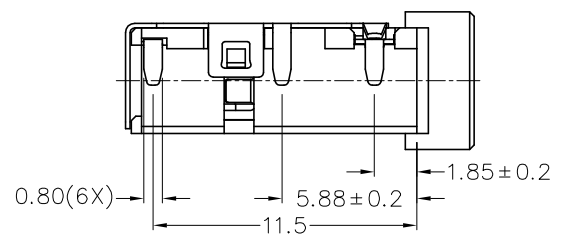

2

2

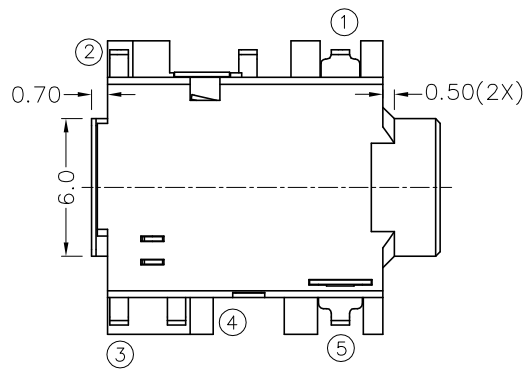

* MATERIAL

- TERMINAL 1 : COPPER ALLOY
- TERMINAL 2 : COPPER ALLOY
- TERMINAL 3 : COPPER ALLOY
- TERMINAL 4 : COPPER ALLOY
- TERMINAL 5 : COPPER ALLOY
- SHIELD : COPPER ALLOY
- HOUSING : PA6T

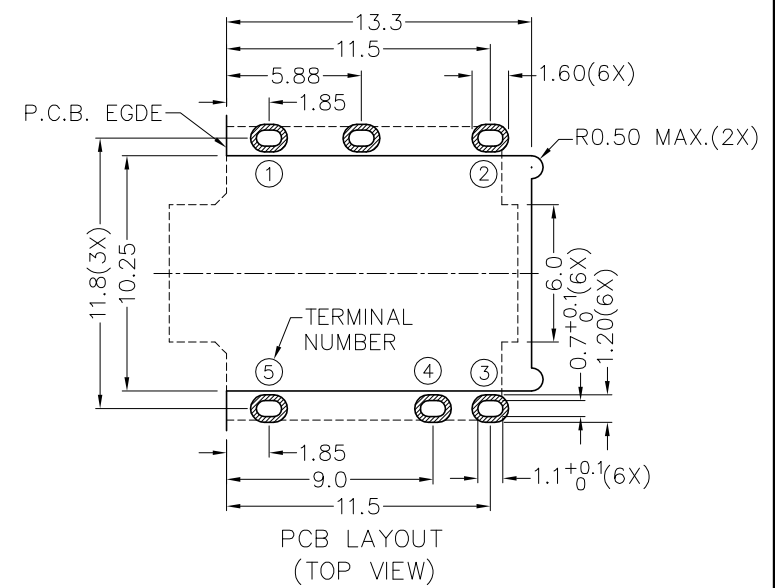

3

3

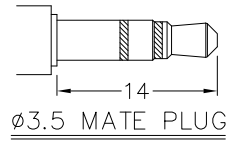

4

4

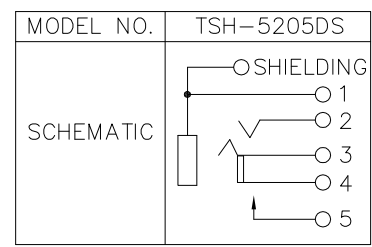

CHAMPWAY 冠泰电子有限公司
CHAMPWAY ELECTRONICS CO., LTD.

DESIGN	H.L.TAN	DATE	12-5-2011	SCALE	3:1
DRAWING	H.L.TAN	DATE	12-5-2011	MATERIAL	*
CHECK		DATE		DWG. NO.	TZ\SH520DS-PA6T/A
APPROVAL		DATE		SHEET	

PART NAME	3.5mm SMD STEREO JACK	TOLERANCE UNLESS	0.0±0.2	UNIT:	
PART NO.	TSH-520DS	OTHERWISE SPECIFIED:	0.00±0.1 0.000±0.05		

F

E

D

C

B

A