

ZONE	SYMBOL	REVISION	APPROVAL	DATE

RoHS  
Compliant

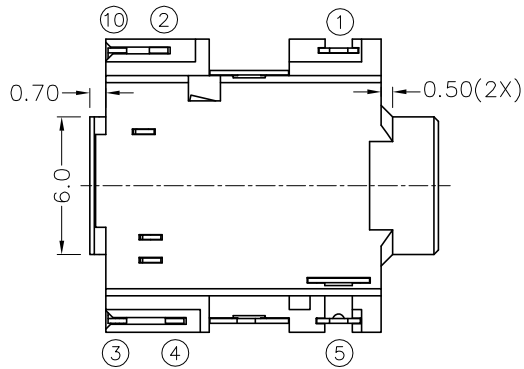
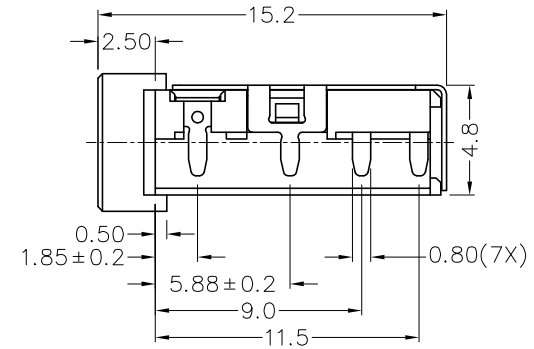
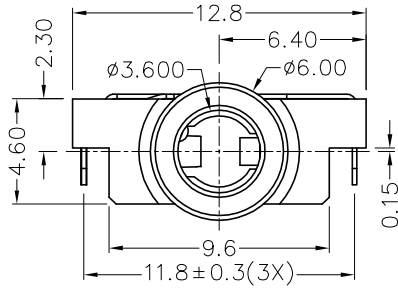
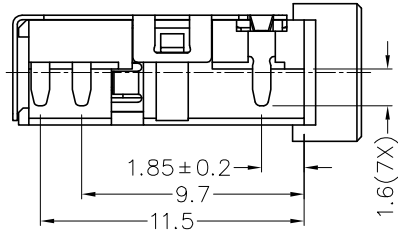
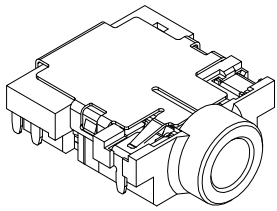

\* MATERIAL

- TERMINAL 1 : COPPER ALLOY
- TERMINAL 2 : COPPER ALLOY
- TERMINAL 3 : COPPER ALLOY
- TERMINAL 4 : COPPER ALLOY
- TERMINAL 5 : COPPER ALLOY
- TERMINAL 10: COPPER ALLOY
- SHIELD : COPPER ALLOY
- HOUSING : PA6T

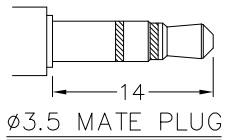
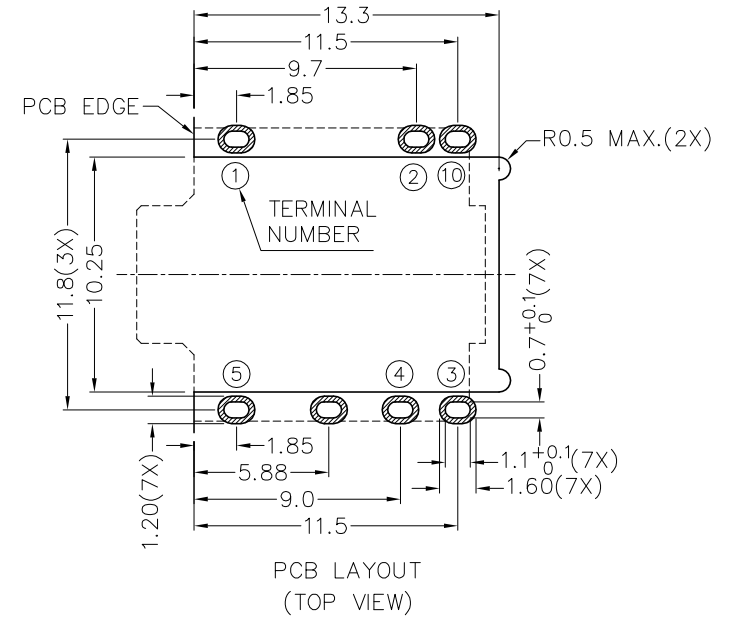
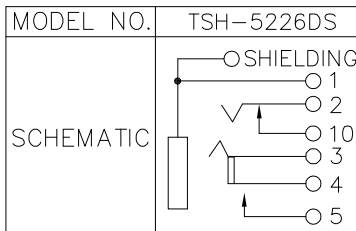

**CHAMPWAY** 冠泰電子有限公司  
CHAMPWAY ELECTRONICS CO., LTD.

PART NAME 3.5mm SMD STEREO JACK  
PART NO. TSH-522DS

TOLERANCE UNLESS 0.0±0.2  
0.00±0.1  
OTHERWISE SPECIFIED: 0.000±0.05

UNIT: mm

DESIGN	H.L.TAN	DATE	12-5-2011	SCALE	3:1
DRAWING	H.L.TAN	DATE	12-5-2011	MATERIAL	*
CHECK		DATE		DWG. NO.	TZ\SH522DS-PA6T/A
APPROVAL		DATE		SHEET	