

F

E

D

C

B

A

ZONE	SYMBOL	REVISION	APPROVAL	DATE
D4		ADD CENTER PIN ITEM	J.X.KUANG	8-6-2007

RoHS  
Compliant

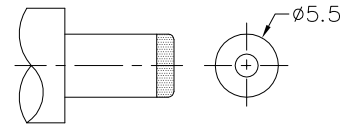
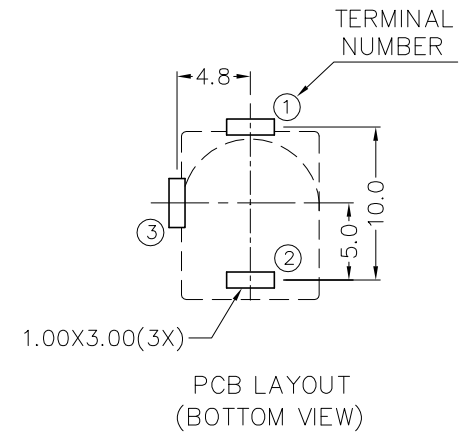
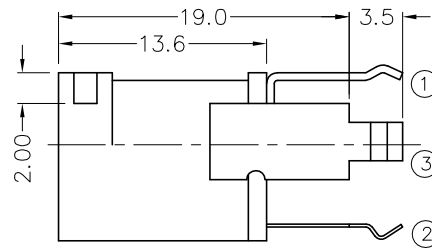
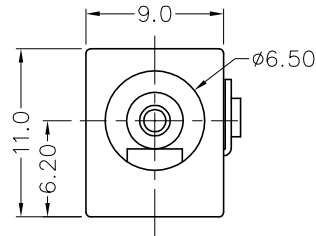
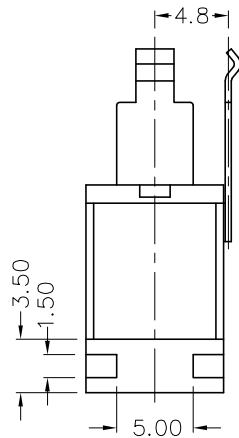
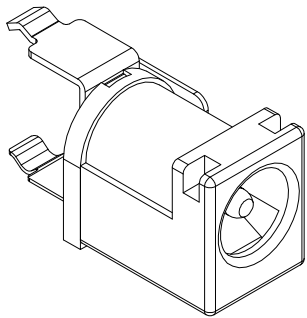

DC MATE PLUG

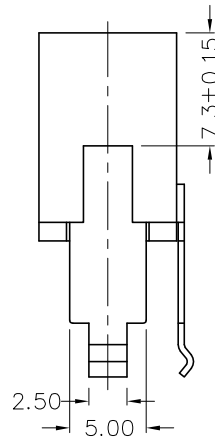

MODEL NO.	TDC-006
SCHEMATIC	
CENTER PIN	ø2mm
	ø2.35mm
	ø2.5mm

\* MATERIAL

CENTRE PIN : COPPER  
 TERMINAL 1 : BRASS  
 TERMINAL 2 : COPPER ALLOY  
 TERMINAL 3 : BRASS  
 HOUSING : PBT  
 COVER : PBT

**CHAMPWAY** 冠泰電子有限公司  
 CHAMPWAY ELECTRONICS CO., LTD.

DESIGN	J.JIANG	DATE	4-6-2004	SCALE	2:1
DRAWING	T.Y.LI	DATE	8-6-2007	MATERIAL	*
CHECK		DATE		DWG. NO.	TZ\DC006-PBT/C
APPROVAL		DATE		SHEET	

PART NAME	DC POWER SOCKET	TOLERANCE UNLESS	0.0±0.2	UNIT:
PART NO.	TDC-006	OTHERWISE SPECIFIED:	0.00±0.1 0.000±0.05	

F

E

D

C

B

A